

ZXM-AC5

Waterproof 4K UHD Action Camera

USER MANUAL



ZERO-X

CONTENTS

1.0	INTRODUCTION	6
2.0	ABOUT THE ZXM-AC5	6
3.0	WHATS IN THE BOX	7
4.0	COMPONENTS	7
5.0	GETTING STARTED	7
5.1	CHARGING THE BATTERY	9
5.2	MICRO SD CARD COMPATIBILITY	10
5.3	TOUCH SCREEN COMPONENTS	10
5.4	POWERING ON YOUR ZXM-AC5.....	10
5.5	FORMAT YOUR MICRO SD CARD.....	11
6.0	ZXM-AC5 CONTROLS AND FUNCTIONS	12
6.1	POWER ON/OFF BUTTON	12
6.2	SHOOT/RECORD BUTTON	12
6.3	The MODE BUTTON.....	12
6.4	ACCESSING SYSTEM SETTINGS.....	13
6.5	SETTING THE TIME.....	13
6.6	SETTING THE DATE FORMAT	14

6.7	SETTING THE DATE.....	15
6.8	AUTO POWER OFF.....	16
6.9	WiFi.....	17
6.10	WiFi INFORMATION.....	18
6.11	RE-SET WiFi.....	19
6.12	ROTATE IMAGE.....	20
6.13	DVR MODE.....	21
6.14	SCREEN SAVER.....	22
6.15	LED INDICATOR.....	23
6.16	KEYPAD TONE.....	24
7.0	PICTURE & VIDEO SETTINGS	25
7.1	VIDEO MODE.....	26
7.2	SLOW MODE.....	28
7.3	LOOP MODE.....	30
7.4	LAPSE MODE.....	32
7.5	PHOTO MODE.....	34
7.6	AUTO MODE.....	36
7.7	BURST MODE.....	38

7.8	TIMER MODE.....	40
7.9	PLAYBACK MODE.....	42
8.0	RESTORE DEFAULT SETTINGS.....	43
9.0	FIRMWARE VERSION.....	44
10.0	INSTALLING AND USING THE ZX-ACTION APP.....	45
11.0	MANUAL STEPS FOR CONNECTING TO THE ZX-ACTION APP... ..	45
11.1	ZX-ACTION APP.....	46
11.2	SAVING PHOTOS AND VIDEOS VIA THE APP.....	47
11.3	REMOTE PHOTO/RECORD VIA THE APP.....	48
11.4	ADJUSTING SETTINGS VIA THE APP.....	48
12.0	WARRANTY TERMS & CONDITIONS.....	49

1.0 INTRODUCTION

Thank you for purchasing a ZXM-AC5 action camera. Please read through this User Manual before attempting to use the ZXM-AC5.

FEATURES

- 4K UHD Recording
- 2.0" LCD Display Screen
- Waterproof without protective case up to 10 metres underwater

2.0 ABOUT THE ZXM-AC5

The Zero-X ZXM-AC5 shoots footage with dynamic realism, where action is effortlessly captured into moments you can keep. The ZXM-AC5 comes with a range of included accessories to create fully immersive footage. To learn more about our extended accessory range and for details on stockists, please visit the Zero-X website.

www.zero-x.com.au | www.zero-x.co.nz.

Please note, the ZXM-AC5 is waterproof to a depth of up to 10 metres / 1 atmosphere without its waterproof case.

A waterproof case is also included with the ZXM-AC5 to use as a protective case during action sports (it is more protective if the camera is dropped on a hard surface), and also if you want to submerge the camera up to 30 metres underwater.

3.0 WHATS IN THE BOX

- 1 x ZXM-AC5 Action Camera
- 1 x USB Charging & Data Cable
- 1 x Waterproof Casing
- 1 x Bike Mount
- 2 x Quick Release Mounts
- 2 x 3M Adhesive Mounts
- 3 x 3 Way Mounts

- 1 x Frame Mount
- 4 x Straps
- 1 x Helmet Base
- 1 x Adaptor Mount
- 1 x Metal Tether
- 2 x 3M Adhesive Pads

4.0 COMPONENTS

5.0 GETTING STARTED

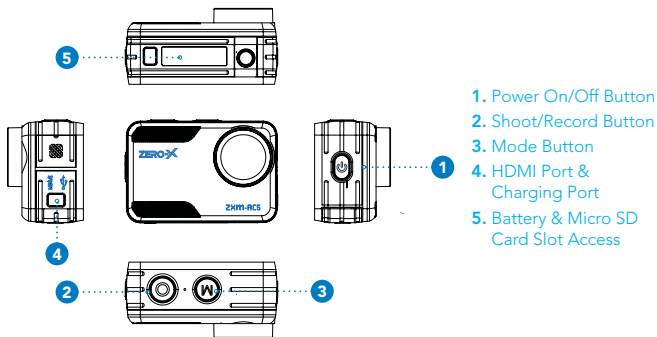

CAUTION:

Before using your action camera please ensure you read and understand the following product and safety precautions.

- Do not use the ZXM-AC5 without water proof case deeper than 10M.
- Do not use the ZXM-AC5 with the waterproof case in water deeper than 30M.
- Always check the waterproof case seal is clean and free of debris prior to use in water.
- Do not attempt to open the ZXM-AC5 or modify it in any way. If the ZXM-AC5 has been tampered with the warranty will be void. Maintenance and repairs should only be performed by Zero-X.
- Only recharge the ZXM-AC5 battery using the supplied USB cable.
- Do not use the ZXM-AC5 in temperatures that exceed 55°C.
- Do not drop, crush, pierce, bend, deform, microwave, incinerate or shoot the ZXM-AC5.

BATTERY WARNING

Always charge the ZXM-AC5 using the provided USB Cable. If the ZXM-AC5 is not charged as directed in this manual, the battery may become damaged and fail.

- Never dismantle the ZXM-AC5 or expose the internal battery cell.
- Do not dispose of the ZXM-AC5 in fire.
- Please dispose of the ZXM-AC5 mindfully and observe local regulations, especially in regards to the safe disposal of the internal battery. Check your local recycling facility for more information.
- Only use a certified 5V 1.5A USB charger to charge the ZXM-AC5. Using non certified chargers could potentially damage the ZXM-AC5, or the ZXM-AC5 battery and void the warranty.
- Do not let the battery charge overnight.
- If the ZXM-AC5 seems to still need charging after three hours, temporarily remove it from its charger as the battery may overheat. Let it cool down for 30 minutes and try charging again.

5.1 CHARGING THE BATTERY

We recommend that you fully charge your ZXM-AC5 before use. A full charge will take approximately 3.0 hours using a 5V 1.5A Charger.

5.2 MICRO SD CARD COMPATIBILITY

The ZXM-AC5 requires a Micro SD Card (not included) to save the files. We recommend you use a maximum 128GB, UHS Class 3 or higher Micro SD Card from a well known brand.

NOTE: There is only one correct way to insert the Micro SD Card into your ZXM-AC5. It should easily slide in. Do not force the card into the slot as it may damage the unit and the card.

5.3 TOUCH SCREEN COMPONENTS

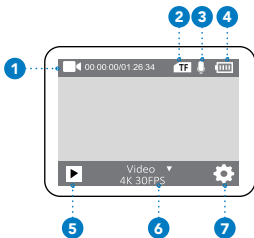

1. Current Mode
2. Micro SD Card Inserted
3. Microphone ON
4. Battery Level
5. Playback
6. Mode Selection
7. Settings



5.4 POWERING ON YOUR ZXM-AC5

To power **ON** your ZXM-AC5 follow the below steps:

1. Insert the battery into the unit.
2. **PRESS** and hold the **ON/OFF BUTTON** on the side of the unit until the start up screen appears.

5.5 FORMAT YOUR MICRO SD CARD

Before you start using the ZXM-AC5, we recommend that you format the Micro SD card. You are able to format the Micro SD card using the ZXM-AC5. The instructions on how to do this are listed below:

1. If you are currently in **VIDEO MODE** and **RECORDING**, you will need to **PRESS** the **SHOOT/RECORD BUTTON** to end the recording first.
2. Once the ZXM-AC5 is fully charged insert your Micro SD Card into the correct slot (see the **"4.0 COMPONENTS"**).
3. **PRESS** the **ON/OFF BUTTON** on the side of the unit to turn **ON** the ZXM-AC5.
4. **PRESS** the  **BUTTON** on the bottom right of the back screen, this will open up the **SETTINGS MENU**. A pop up with two locks and arrows may appear. Swipe from left to right. You may need to **PRESS** the  **BUTTON** again.
5. **PRESS** the  tab on the left side of the screen. The current section tab will be highlighted blue.
6. Scroll down the list by swiping from bottom to top until you reach **FORMAT SD CARD**. **PRESS** on this option.
7. You will be prompted with the options **FORMAT** and **CANCEL**. **PRESS** on the option that you require. Your Micro SD card will now format.

NOTE: Formatting the Micro SD card will permanently erase all data stored on the Micro SD card. Be sure to back up all saved data prior to formatting.

6.0 ZXM-AC5 CONTROLS AND FUNCTIONS

6.1 POWER ON/OFF BUTTON

The **ON/OFF BUTTON** is located at the side of the ZXM-AC5. This is used to turn **ON/OFF** the unit.

The **ON/OFF BUTTON** is also used to change between the Video/Photo in preview interface, the Video Settings, Photo Settings, General Settings and Exit in setting menu. It also serves as the back button when you are in the navigation settings.

6.2 SHOOT/RECORD BUTTON

The **SHOOT/RECORD BUTTON** is located on right side on top of the ZXM-AC5. This button is used to shoot images and also record videos (start and stop videos).



The **SHOOT/RECORD BUTTON** is also used to access the navigation **SETTINGS MENUS**, select menu items, and confirm your selection.

6.3 THE MODE BUTTON

The **MODE BUTTON** is located on the top of the ZXM-AC5 on the left side. This button is used to access the navigation **SETTING MENUS** and to scroll down in the setting menu.



6.4 ACCESSING SYSTEM SETTINGS

You can access system settings when using any of the camera modes.

1. If you are currently in **VIDEO MODE** and **RECORDING**, you will need to press the **SHOOT/RECORD BUTTON** to end the recording first.
2. **PRESS** the  **BUTTON** on the bottom right of the back screen, this will open up the **SETTINGS MENU**. A pop up with two locks and arrows may appear. Swipe from left to right. You may need to **PRESS** the  **BUTTON** again.

6.5 SETTING THE TIME

To set the correct time on your ZXM-AC5, follow the below steps once your unit is turned ON. You can set the time and date in separate settings.



1. If you are currently in **VIDEO MODE** and **RECORDING**, you will need to press the **SHOOT/RECORD BUTTON** to end the recording first.
2. **PRESS** the  **BUTTON** on the bottom right of the back screen, this will open up the **SETTINGS MENU**. A pop up with two locks and arrows may appear. Swipe from left to right. You may need to **PRESS** the  **BUTTON** again.
3. **PRESS** the  tab on the left side of the screen. The current section tab will be highlighted blue.

4. Scroll down the list by swiping from bottom to top until you reach **TIME SETTING**. **PRESS** on this option. The time settings screen will pop up.
5. You will be prompted to fill in the current hour, minute and seconds. Navigate by pressing either the hour, minute and second on the screen. To change the numbers, **PRESS** the **UP** and **DOWN ARROWS** on the screen until you reach the required number.
6. Once you have adjusted the time, confirm by pressing the **TICK** on the screen in the top right corner. The time will now be updated.

NOTE: The option which is bold and black is the active selection. Non active options are grey. The time is 24 hour and is set as HH:MM:SS.

6.6 SETTING THE DATE FORMAT



The ZXM-AC5 has 3 date formats you can choose from, including how the date is displayed. The options are **YYYY/MM/DD**, **MM/DD/YYYY** and **DD-MM-YYYY**. The ZXM-AC5 default setting is **DD/MM/YYYY**. To change follow the below steps:

1. If you are currently in **VIDEO MODE** and **RECORDING**, you will need to press the **SHOOT/RECORD BUTTON** to end the recording first.
2. **PRESS** the  **BUTTON** on the bottom right of the back screen, this will open up the **SETTINGS MENU**. A pop-up with two locks and arrows may appear. Swipe from left to right. You may need to **PRESS** the  **BUTTON** again.

3. **PRESS** the  tab on the left side of the screen. The current section tab will be highlighted blue.
4. Scroll down the list by swiping from bottom to top until you reach **DATE FORMAT**. **PRESS** on this option. The **DATE FORMAT SETTINGS** screen will pop up.
5. **PRESS** on the option that you prefer. The **DATE FORMAT** will now be updated.

6.7 SETTING THE DATE

To set the correct date on your ZXM-AC5, follow the below steps. You set the time and date in separate settings.

1. If you are currently in **VIDEO MODE** and **RECORDING**, you will need to press the **SHOOT/RECORD BUTTON** to end the recording first.
2. **PRESS** the  **BUTTON** on the bottom right of the back screen, this will open up the **SETTINGS MENU**. A pop up with two locks and arrows may appear. Swipe from left to right. You may need to **PRESS** the  **BUTTON** again.
3. **PRESS** the  tab on the left side of the screen. The current section tab will be highlighted blue.
4. Scroll down the list by swiping from bottom to top until you reach **DATE SETTING**. **PRESS** on this option. The **DATE SETTING** screen will pop up.

5. You will be prompted to fill in the current year, month and day. Navigate through by pressing on either year, month and day on the screen. To change the numbers **PRESS** the **UP** and **DOWN ARROWS** on the screen until you reach the required number.
6. Once you have adjusted the date, confirm this by pressing the tick on the screen in the top right corner. The time will now be updated.

6.8 AUTO POWER OFF



The auto power OFF function is designed to help extend the battery life of the ZXM-AC5. The ZXM-AC5 will automatically **POWER OFF** after a selected period of inactivity (**3, 5, 10 MINUTES** and **OFF**). The ZXM-AC5 is factory defaulted to **3 MINUTES**. To change this setting, follow the below steps:

1. If you are currently in **VIDEO MODE** and **RECORDING**, you will need to press the **SHOOT/RECORD BUTTON** to end the recording first.
2. **PRESS** the  **BUTTON** on the bottom right of the back screen, this will open up the **SETTINGS MENU**. A pop up with two locks and arrows may appear. Swipe from left to right. You may need to **PRESS** the  **BUTTON** again.
3. **PRESS** the  tab on the left side of the screen. The current section tab will be highlighted blue.

4. Scroll down the list by swiping from bottom to top until you reach **AUTO POWER OFF**. **PRESS** on this option. The **AUTO POWER OFF SETTINGS** screen will pop up.
5. You can scroll through the options by swiping up and down on the screen. **PRESS** on the option that you prefer. The setting will now be updated.

6.9 WIFI

The ZXM-AC5 comes with inbuilt WiFi, allowing you to easily access your footage and photos through your smartphone. The ZXM-AC5 default setting is **OFF**. For more information, see '11.1 ZX-ACTION APP.' To change this setting, follow the below steps:



1. If you are currently in **VIDEO MODE** and **RECORDING**, you will need to press the **SHOOT/RECORD BUTTON** to end the recording first.
2. **PRESS** the  **BUTTON** on the bottom right of the back screen, this will open up the **SETTINGS MENU**. A pop up with two locks and arrows may appear. Swipe from left to right. You may need to **PRESS** the  **BUTTON** again.
3. **PRESS** the  tab on the left side of the screen. The current section tab will be highlighted blue.
4. Scroll down the list by swiping from bottom to top until you reach **WIFI**. You will notice a box on the right of screen with **TURN OFF** next to it. **PRESS** on this box. The WiFi is now activated.

5. To exit out of **WIFI MODE**, **PRESS** the **UP BUTTON**.

NOTE: When WiFi is connected to your smartphone, you cannot use the functions on the ZXM-AC5 via the camera however you can manage functions via the app in this mode. You can also use your smartphone as a wireless recording monitor when in WiFi mode. You can control functions via the ZXM-AC5 camera again once you have finished using the functions of the **ZX-ACTION APP** and disconnect from your smartphone.

6.10 WIFI INFORMATION



If you need to find out the connection name and password of the ZXM-AC5 WiFi ID, you can find this in the WiFi information section. To access this, follow the below steps:

1. If you are currently in **VIDEO MODE** and **RECORDING**, you will need to press the **SHOOT/RECORD BUTTON** to end the recording first.
2. **PRESS** the  **BUTTON** on the bottom right of the back screen, this will open up the **SETTINGS MENU**. A pop up with two locks and arrows may appear. Swipe from left to right. You may need to **PRESS** the  **BUTTON** again.
3. **PRESS** the  tab on the left side of the screen. The current section tab will be highlighted blue.
4. Scroll down the list by swiping from bottom to top until you reach **WIFI INFORMATION**. **PRESS** on this option to see the WiFi ID information.

5. WiFi information will have **WIFI ID** and **WIFI PASSWORD**. The WiFi Name will be ZXM-AC5_XXXX (XXXX will be unique to every action camera) Password: **1234567890**



6.11 RE-SET WIFI

If you need to re-set ZXM-AC5 WiFi connection, follow the below steps:

1. If you are currently in **VIDEO MODE** and **RECORDING**, you will need to press the **SHOOT/RECORD BUTTON** to end the recording first.
2. **PRESS** the  **BUTTON** on the bottom right of the back screen, this will open up the **SETTINGS MENU**. A pop up with two locks and arrows may appear. Swipe from left to right. You may need to **PRESS** the  **BUTTON** again.
3. **PRESS** the  tab on the left side of the screen. The current section tab will be highlighted blue.
4. Scroll down the list by swiping from bottom to top until you reach **RESET WIFI**. **PRESS** on this option.
5. You will be prompted to confirm or cancel. **PRESS** on the option you require. If you **PRESS** confirm, the **WIFI** will be re-set.



6.12 ROTATE IMAGE

You have the ability to flip the image vertically (upside down) when you are using the ZXM-AC5, by turning on this function. The ZXM-AC5 default setting is **OFF**. To change this setting, follow the steps:

1. If you are currently in **VIDEO MODE** and **RECORDING**, you will need to press the **SHOOT/RECORD BUTTON** to end the recording first.
2. **PRESS** the  **BUTTON** on the bottom right of the back screen, this will open up the **SETTINGS MENU**. A pop up with two locks and arrows may appear. Swipe from left to right. You may need to **PRESS** the  **BUTTON** again.
3. **PRESS** the  tab on the left side of the screen. The current section tab will be highlighted blue.
4. **IMAGE ROTATION** is the first option on the settings menu. You will notice there is a small box with **TURN OFF** next to it. **PRESS** the box to activate this function. It will now say **TURN ON**. The camera image will now be flipped vertically (upside down).



6.13 DVR MODE

When **DVR MODE** is activated, the ZXM-AC5 will continue to record until the unit has run out of power. The ZXM-AC5 default setting is **OFF**. To change this setting, follow the below steps:

1. If you are currently in **VIDEO MODE** and **RECORDING**, you will need to press the **SHOOT/RECORD BUTTON** to end the recording first.
2. **PRESS** the  **BUTTON** on the bottom right of the back screen, this will open up the **SETTINGS MENU**. A pop up with two locks and arrows may appear. Swipe from left to right. You may need to **PRESS** the  **BUTTON** again.
3. **PRESS** the  tab on the left side of the screen. The current section tab will be highlighted blue.
4. Scroll down the list by swiping from bottom to top until you reach **DVR MODE**. You will notice there is a small box with **TURN OFF** next to it. **PRESS** the box to activate this function. It will now say **TURN ON**.

6.14 SCREEN SAVER

You can record videos and conserve power with the screen saver function, allowing the LCD display to turn OFF while the ZXM-AC5 continues to record. There are four options to choose from for the screen saver function activating: **30 SECONDS, 1 MINUTE, 2 MINUTES** and **OFF**. The ZXM-AC5 default setting is set to **30 SECONDS**. To change this setting, follow the below steps:



1. If you are currently in **VIDEO MODE** and **RECORDING**, you will need to press the **SHOOT/RECORD BUTTON** to end the recording first.
2. **PRESS** the  **BUTTON** on the bottom right of the back screen, this will open up the **SETTINGS MENU**. A pop up with two locks and arrows may appear. Swipe from left to right. You may need to **PRESS** the  **BUTTON** again.
3. **PRESS** the  tab on the left side of the screen. The current section tab will be highlighted blue.
4. Scroll down the list by swiping from bottom to top until you reach **SCREEN SAVER**. **PRESS** on this option. The **SCREEN SAVER SETTINGS** screen will pop up.
5. You can scroll through the options by swiping **UP** and **DOWN** on the screen. **PRESS** on the option that you prefer. The setting will now be updated.

6.15 LED INDICATOR

The ZXM-AC5 has LED indicator lights that allow you to see if a function is active. There is two small LED indicator lights on the left side of the screen;



- The **RED LED** indicator light shows the ZXM-AC5 is charging.
- The **BLUE LED** indicator light will stay solid blue when not recording, and when recording will flash blue.

The ZXM-AC5 default setting is set to **ON**. To change this setting, follow the below steps:

1. If you are currently in **VIDEO MODE** and **RECORDING**, you will need to press the **SHOOT/RECORD BUTTON** to end the recording first.
2. **PRESS** the  **BUTTON** on the bottom right of the back screen, this will open up the **SETTINGS MENU**. A pop-up with two locks and arrows will appear. Swipe from left to right. You may need to **PRESS** the  **BUTTON** again.
3. **PRESS** the  tab on the left side of the screen. The current section tab will be highlighted blue.
4. Scroll down the list by swiping from bottom to top until you reach **LED INDICATOR**. You will notice there is a small box with a tick on it and **TURN ON** next to it. **PRESS** the box to deactivate this function. It will now say **TURN OFF**.

6.16 KEYPAD TONE

You have the ability to change the volume of your keypad tone on the ZXM-AC5. There are 3 volumes to choose from (High, Middle and Low). The ZXM-AC5 default setting is Middle. To change, follow the below steps.

1. If you are currently in **VIDEO MODE** and **RECORDING**, you will need to press the **SHOOT/RECORD BUTTON** to end the recording first.
2. **PRESS** the  **BUTTON** on the bottom right of the back screen, this will open up the **SETTINGS MENU**. A pop up with two locks and arrows may appear. Swipe left to right. You may need to **PRESS** the  **BUTTON** again.
3. **PRESS** the  tab on the left side of the screen. The current section tab will be highlighted blue.
4. Scroll down the list by swiping from bottom to top until you reach **KEYPAD TONE**. **PRESS** on this option. The **KEYPAD TONE SETTINGS** screen will pop up.
5. You can scroll through the options by swiping **UP** and **DOWN** on the screen. **PRESS** on the option that you prefer. The setting will now be updated.

7.0 PICTURE & VIDEO SETTINGS

There are multiple shooting functions that the ZXM-AC5 offers. You have the choice of 8 options: **VIDEO**, **SLOW**, **LOOP**, **LAPSE**, **PHOTO**, **AUTO**, **BURST** and **TIMER**. To access the mode selection panel follow the below steps:

1. On the back screen, press the **MODE SELECTION** drop down (See “**5.3 TOUCH SCREEN COMPONENTS**”).

This will open up the screen (image to the right) where you can select a **MODE** from this panel.

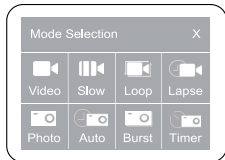



VIDEO	SLOW	LOOP	LAPSE
Stands for VIDEO MODE	Stands for SLOW MOTION MODE	Stands for LOOP RECORDING MODE	Stands for TIME LAPSE MODE
PHOTO	AUTO	BURST	TIMER
Stands for PHOTO MODE	Stands for AUTO PHOTO MODE	Stands for BURST MODE	Stands for PHOTO TIMER MODE

7.1 VIDEO MODE

To use **VIDEO MODE**, follow the steps under '**7.0 PICTURE & VIDEO SETTINGS.**' Press on **VIDEO** to activate this mode.

There are multiple settings in this mode that you can adjust to your preferred option. To change these settings please follow the below steps once you are in **VIDEO MODE**.

1. If you are currently in **VIDEO MODE** and **RECORDING**, you will need to press the **SHOOT/RECORD BUTTON** to end the recording first.
2. **PRESS** the  **BUTTON** on the bottom right of the back screen, this will open up the settings menu. A pop up with two locks and arrows may appear. Swipe from left to right. You may need to **PRESS** the  **BUTTON** again.
3. The settings will open up on the **VIDEO MODE SETTINGS** automatically. Swipe up and down to scroll through and adjust the settings.
4. To adjust, **PRESS** on the setting you wish to change and **PRESS** on the option you wish to change. This will update the setting.

Please see the table on the next page to view other available settings.

NOTE: These settings are applicable for **VIDEO MODE** only.

SETTING	OPTIONS	ZXM-AC5 DEFAULT
Resolution	4K @ 60 FPS, 4K @ 30 FPS, 2.7K @ 30FPS, 1080P @ 120FPS, 1080P @ 60 FPS, 1080P @ 30FPS, 720P @ 240FPS, 720P @ 120FPS, 720P @ 60 FPS, 720P @ 30FPS	4K @30 FPS
Electronic Image Stabilisation	ON / OFF	ON
Distortion Correction	ON / OFF	OFF
White Balance	Auto / Sunny / Cloudy / Incandescent / Fluorescence	Auto
Exposure	3 / 2 / 1 / 0 / -1 / -2 / -3	0
Metering Mode	Average Metering / Center Metering / Spot Metering / Matrix Metering	Average Metering
Sharpness	High / Middle / Low	Middle
ISO	Auto /100 / 200 / 400 / 800 / 1600 / 3200 / 6400	Auto
Time Stamp	ON / OFF	ON
Microphone	ON / OFF	ON

NOTE: When **ELECTRONIC IMAGE STABILISATION** is turned **ON**, **DISTORTION CORRECTION** will be **OFF** and vice versa.

7.2 SLOW MODE

To use **SLOW MODE** (Slow Motion), follow the steps under '**7.0 PICTURE & VIDEO SETTINGS.**' Press **SLOW** to activate this mode. There are multiple settings in this mode that you can adjust to your preferred option. To change these settings please follow the below steps once you are in **SLOW MODE**.

1. If you are currently in **VIDEO MODE** and **RECORDING**, you will need to **PRESS** the **SHOOT/RECORD BUTTON** to end the recording first.
2. **PRESS** the  **BUTTON** on the bottom right of the back screen, this will open up the **SETTINGS MENU**. A pop up with two locks and arrows may appear. Swipe from left to right. You may need to **PRESS** the  **BUTTON** again.
3. The settings will open up on the **SLOW MODE SETTINGS** automatically. Swipe up and down to scroll through the settings you can adjust.
4. To adjust, **PRESS** on the setting you wish to change and **PRESS** the option you wish to change. This will update the setting.

Please see the table on the next page to view other available settings.



NOTE: These settings are applicable for **SLOW MOTION MODE** only.

SETTING	OPTIONS	ZXM-AC5 DEFAULT
Resolution	1080P 4X, 1080P 2X, 720P 8X, 720P 4X	1080P 4X
White Balance	Auto / Sunny / Cloudy / Incandescent / Fluorescence	Auto
Exposure	3 / 2 / 1 / 0 / -1 / -2 / -3	0
Metering Mode	Average Metering / Center Metering / Spot Metering / Matrix Metering	Average Metering
Sharpness	High / Middle / Low	Middle
Video Quality	High / Middle / Low	High

7.3 LOOP MODE

To use **LOOP MODE** (also known as Loop Recording), follow the steps under '7.0 PICTURE & VIDEO SETTINGS.' Press **LOOP** to activate this mode.

There are multiple settings in this mode that you can adjust to your preferred option. To change these settings please follow the below steps once you are in **LOOP MODE**.

1. If you are currently in **VIDEO MODE** and **RECORDING**, you will need to press the **SHOOT/RECORD BUTTON** to end the recording first.
2. **PRESS** the  **BUTTON** on the bottom right of the back screen, this will open up the **SETTINGS MENU**. A pop up with two locks and arrows may appear. Swipe from left to right. You may need to **PRESS** the  **BUTTON** again.
3. The settings will automatically open the **LOOP MODE**.
Swipe up and down to scroll through the settings to adjust.
4. To adjust, **PRESS** on the setting you wish to change and **PRESS** on the option you wish to change. This will update the setting.

Please see the table on the next page to view other available settings.

NOTE: These settings are applicable for **LOOP RECORDING MODE** only.



SETTING	OPTIONS	ZXM-AC5 DEFAULT
Resolution	4K @ 60 FPS, 4K @ 30 FPS, 2.7K @ 30FPS, 1080P @ 120FPS, 1080P @ 60 FPS, 1080P @ 30FPS, 720P @ 240FPS, 720P @ 120FPS, 720P @ 60 FPS, 720P @ 30FPS	4K @ 30 FPS
Loop Recording	2 / 3 / 5 Mins	2 Mins
Electronic Image Stabilisation	ON / OFF	ON
Distortion Correction	ON / OFF	OFF
White Balance	Auto / Sunny / Cloudy / Incandescent / Fluorescence	Auto
Exposure	3 / 2 / 1 / 0 / -1 / -2 / -3	0
Metering Mode	Average Metering / Center Metering / Spot Metering / Matrix Metering	Average Metering
Sharpness	High / Middle / Low	Middle
ISO	Auto / 100 / 200 / 400 / 800 / 1600 / 3200 / 6400	Auto
Video Quality	High / Middle / Low	High
Time Stamp	ON / OFF	ON
Microphone	ON / OFF	ON

NOTE: When **ELECTRONIC IMAGE STABILISATION** is turned **ON**, **DISTORTION CORRECTION** will be **OFF** and vice versa.

7.4 LAPSE MODE

To use **LAPSE MODE** (also know as time lapse mode which takes a sequence of photos in a selected interval of time). Follow the steps under '**7.0 PICTURE & VIDEO SETTINGS.**' Press **LAPSE** to activate this mode.

There are multiple settings in this mode that you can adjust. To change these settings please follow the below steps once you are in **LAPSE MODE**.

1. If you are currently in **VIDEO MODE** and **RECORDING**, you will need to press the **SHOOT/RECORD BUTTON** to end the recording first.
2. **PRESS** the  **BUTTON** on the bottom right of the back screen, this will open up the **SETTINGS MENU**. A pop up with two locks and arrows may appear. Swipe from left to right. You may need to **PRESS** the  **BUTTON** again.
3. The settings will open up on the **LAPSE MODE SETTINGS** automatically. Swipe up and down to scroll through the settings you can adjust.
4. To adjust, **PRESS** on the setting you wish to change and **PRESS** on the option you wish to change. This will update the setting.

Please see the table on the next page to view other available settings.



NOTE: These Settings are applicable for **TIME LAPSE MODE** only.

SETTING	OPTIONS	ZXM-AC5 DEFAULT
Resolution	4K / 2.7K / 1080P / 720P	4K
Interval	0.5 Secs / 1 second / 2 seconds / 5 seconds / 10 seconds / 30 seconds / 60 seconds	0.5 seconds
White Balance	Auto / Sunny / Cloudy / Incandescent / Fluorescence	Auto
Exposure	3 / 2 / 1 / 0 / -1 / -2 / -3	0
Video Length	Unlimited / 6 seconds / 8 seconds / 10 seconds / 20 seconds / 30 seconds / 60 seconds / 120 seconds	Unlimited
Metering Mode	Average Metering / Center Metering / Spot Metering / Matrix Metering	Average Metering
Sharpness	High / Middle / Low	Middle
ISO	Auto / 100 / 200 / 400 / 800 / 1600 / 3200 / 6400	Auto
Video Quality	High / Middle / Low	High

7.5 PHOTO MODE

To use **PHOTO MODE**, follow the steps under '**7.0 PICTURE & VIDEO SETTINGS.**' Press **PHOTO** to activate this mode.

There are multiple settings in this mode that you can adjust to your preferred option. To change these settings please follow the below steps once you are in **PHOTO MODE**.

1. **PRESS** the  **BUTTON** on the bottom right of the back screen, this will open up the **SETTINGS MENU**. A pop up with two locks and arrows may appear. Swipe from left to right. You may need to **PRESS** the  **BUTTON** again.
2. The settings will open up on the **PHOTO MODE SETTINGS** automatically. Swipe up and down to scroll through the settings you can adjust.
3. To adjust, select the setting you wish to change and **PRESS** the option you wish to change. This will update the setting.

Please see the table on the next page to view other available settings.



NOTE: These settings will be applicable for **PHOTO MODE** only.

SETTING	OPTIONS	ZXM-AC5 DEFAULT
Image Resolution	16 / 13 / 8 Megapixels	16M
White Balance	Auto / Sunny / Cloudy / Incandescent / Fluorescence	Auto
Exposure	3 / 2 / 1 / 0 / -1 / -2 / -3	0
Metering Mode	Average Metering / Center Metering / Spot Metering / Matrix Metering	Average Metering
Sharpness	High / Middle / Low	Middle
Long Exposure	Auto / 2 / 5 / 10 / 15 / 20 / 30	Auto
ISO	Auto /100 / 200 / 400 / 800 / 1600 / 3200 / 6400	Auto
Time and Date Stamp	ON / OFF	ON

7.6 AUTO MODE

To use **AUTO MODE** (takes continuous photos with a selected time interval between each photo), follow the steps under '**7.0 PICTURE & VIDEO SETTINGS.**' Press **AUTO** to activate this mode.

There are multiple settings in this mode where you can select your preferred option. To change these settings please follow the below steps once you are in **AUTO MODE**.

1. **PRESS** the  **BUTTON** on the bottom right of the back screen, this will open up the **SETTINGS MENU**. A pop-up with two locks and arrows may appear. Swipe from left to right. You may need to **PRESS** the  **BUTTON** again.
2. The settings will open up on the **AUTO MODE SETTINGS** automatically. Swipe up and down to scroll through the settings to adjust.
3. To adjust, **PRESS** on the setting you wish to change and **PRESS** on the option you wish to change. This will update the setting.

Please see the table on the next page to view other available settings.



NOTE: These settings will be applicable for **AUTO MODE** only.

SETTING	OPTIONS	ZXM-AC5 DEFAULT
Image Resolution	16 / 13 / 8 Megapixels	16M
Time Interval	3 seconds / 10 seconds / 15 seconds / 20 seconds / 30 seconds	3 seconds
White Balance	Auto / Sunny / Cloudy / Incandescent / Fluorescence	Auto
Exposure	3 / 2 / 1 / 0 / -1 / -2 / -3	0
Metering Mode	Average Metering / Center Metering / Spot Metering / Matrix Metering	Average Metering
Sharpness	High / Middle / Low	Middle
ISO	Auto /100 / 200 / 400 / 800 / 1600 / 3200 / 6400	Auto
Time and Date Stamp	ON / OFF	ON

7.7 BURST MODE

To use **BURST MODE** (takes a preset amount of photos in one second), follow the steps under '**7.0 PICTURE & VIDEO SETTINGS.**' Press **BURST** to activate this mode.

There are multiple settings in this mode where you can select your preferred option. To change these settings please follow the below steps once you are in **BURST MODE**.

1. **PRESS** the  **BUTTON** on the bottom right of the back screen, this will open up the **SETTINGS MENU**. A pop up with two locks and arrows may appear. Swipe from left to right. You may need to **PRESS** the  **BUTTON** again.
2. The settings will open up on the **BURST MODE SETTINGS** automatically. Swipe up and down to scroll through the settings you can adjust.
3. To adjust, **PRESS** on the setting you wish to change and **PRESS** on the option you wish to change. This will update the setting.

Please see the table on the next page to view other available settings.



NOTE: These settings will be applicable for **BURST MODE** only.

SETTING	OPTIONS	ZXM-AC5 DEFAULT
Image Resolution	16 / 13 / 8 Megapixels	16M
Photo Frequency	3 Pictures/sec, 5 Pictures/sec, 10 Pictures/sec	3 Pictures/sec
White Balance	Auto / Sunny / Cloudy / Incandescent / Fluorescence	Auto
Exposure	3 / 2 / 1 / 0 / -1 / -2 / -3	0
Metering Mode	Average Metering / Center Metering / Spot Metering / Matrix Metering	Average Metering
Sharpness	High / Middle / Low	Middle
ISO	Auto / 100 / 200 / 400 / 800 / 1600 / 3200 / 6400	Auto
Time and Date Stamp	ON / OFF	ON

7.8 TIMER MODE

To use **TIMER MODE** (takes photos with a preselected timed countdown), follow the steps under '**7.0 PICTURE & VIDEO SETTINGS.**' Press **TIMER** to activate this mode:

There are multiple settings in this mode where you can select your preferred option. To change these settings please follow the below steps once you are in timer mode.

1. **PRESS** the  **BUTTON** on the bottom right of the back screen, this will open up the **SETTINGS MENU**. A pop up with two locks and arrows may appear. Swipe from left to right. You may need to **PRESS** the  **BUTTON** again.
2. The settings will open up on the **TIMER MODE SETTINGS** automatically. Swipe up and down to scroll through the settings you can adjust.
3. To adjust, **PRESS** on the setting you wish to change and **PRESS** on the option you wish to change. This will update the setting.



Please see the table on the next page to view settings.

NOTE: These settings will be applicable for **TIMER MODE** only.

SETTING	OPTIONS	ZXM-AC5 DEFAULT
Image Resolution	16 / 13 / 8 Megapixels	16M
Count Down	3 seconds / 5 seconds / 10 seconds / 20 seconds	3 seconds
White Balance	Auto / Sunny / Cloudy / Incandescent / Fluorescence	Auto
Exposure	3 / 2 / 1 / 0 / -1 / -2 / -3	0
Metering Mode	Average Metering / Center Metering / Spot Metering / Matrix Metering	Average Metering
Sharpness	High / Middle / Low	Middle
ISO	Auto / 100 / 200 / 400 / 800 / 1600 / 3200 / 6400	Auto
Time and Date Stamp	ON / OFF	ON



7.9 PLAYBACK MODE

To view photos and the videos you have taken with the ZXM-AC5 use **PLAYBACK MODE**. To operate, **PRESS** the  **ICON** on the bottom left on the screen. This will open up the **PHOTO/VIDEO GALLERY**.

To scroll through the photos and videos **PRESS** the  **ICON** to navigate left and **PRESS** the  **ICON** to navigate right. If it is a video, a  **ICON** will appear in the middle of the screen.

To exit **PLAYBACK MODE**, **PRESS** the **BACK BUTTON** on the bottom left of the screen. Alternatively, you can also **PRESS** the **UP BUTTON** to exit playback mode.

7.9.1 WATCHING VIDEOS IN PLAYBACK MODE

To watch videos in playback mode, **PRESS** the  **ICON** that is in the middle of the video, or **PRESS** the **SHOOT/RECORD BUTTON**. To pause this video, **PRESS** the  **ICON** that is in the middle of the video, or press the **SHOOT/RECORD BUTTON** again.



7.9.2 DELETING FILES IN PLAYBACK MODE

To delete any files that have been taken on the ZXM-AC5 or are on the Micro SD Card, **PRESS** the **TRASH CAN ICON** on the bottom right corner of the screen. You will be prompted to confirm or cancel. **PRESS CONFIRM** to delete.

8.0 RESTORE DEFAULT SETTINGS

This setting will restore the ZXM-AC5 to factory default. All setting adjustments made to the unit will be erased.



If you need to restore to factory settings, follow the below steps:

1. If you are currently in **VIDEO MODE** and **RECORDING**, you will need to press the **SHOOT/RECORD BUTTON** to end the recording first.
2. **PRESS** the  **BUTTON** on the bottom right of the back screen, this will open up the settings menu. A pop up with two locks and arrows may appear. Swipe from left to right. You may need to **PRESS** the  **BUTTON** again.
3. **PRESS** the  tab on the left side of the screen. The current section tab will be highlighted blue.
4. Scroll down the list by swiping from bottom to top until you reach **RESTORE DEFAULT SETTING**. **PRESS** on this option. You will be prompted to either confirm or cancel. **PRESS** the option you require.

Once the ZXM-AC5 factory reset has been confirmed, the unit will turn off. You will need to turn on the unit again by **PRESSING** the **ON/OFF BUTTON**.

9.0 FIRMWARE VERSION

To check the current **FIRMWARE** of your ZXM-AC5, follow the below steps:

1. If you are currently in **VIDEO MODE** and **RECORDING**, you will need to press the **SHOOT/RECORD BUTTON** to end the recording first.
2. **PRESS** the  **BUTTON** on the bottom right of the back screen, this will open up the settings menu. A pop up with two locks and arrows may appear. Swipe from left to right. You may need to **PRESS** the  **BUTTON** again.
3. **PRESS** the  tab on the left side of the screen. The current section tab will be highlighted blue.
4. Scroll down the list by swiping from bottom to top until you reach **FIRMWARE VERSION**. **PRESS** on this option.
5. To exit, **PRESS** the **ON/OFF BUTTON** once, and then **PRESS** the back button on the screen. This will take you back to the camera's shoot mode.

NOTE: To check if there is a new firmware version available for your action camera, or for instructions on how to update it's firmware, please check for updates on our website. www.zero-x.com.au | www.zero-x.co.nz

10.0 INSTALLING AND USING THE ZX-ACTION APP

Please scan the below QR code.

OR

Please search the App store or Google Play Store for '**ZX-ACTION**'.

NOTE: The **ZX-ACTION APP** requires ios 10.0 and above or Android 5.0 device to run. When using the App, please note: Android users will be taken to a home screen before entering the shoot screen. iPhone users will be taken straight to the shoot screen once they have connected the ZXM-AC5 to the App.

11.0 MANUAL STEPS FOR CONNECTING TO THE ZX-ACTION APP

Turn on your phone and scan the QR code or search the App store for **ZX-ACTION** and download the App.



11.1 ZX-ACTION APP

The ZXM-AC5 has an in-built **WiFi** connection which is used to wirelessly connect your smartphone to your ZXM-AC5, allowing you to use your smartphone as an external wireless monitor, view the files, change settings and trigger recording on your smartphone. To connect your smartphone to the ZXM-AC5, follow the below steps:

1. If you are using an Android smartphone, go to the Google Play Store. If you are using an iPhone go to the Apple store.
2. Search for the App **ZX-ACTION**. Once you have found this App, download and install it. Alternatively you can scan the above QR code to take you directly to the App.

CONNECTING TO THE ZXM-AC5 WiFi

1. Once the App is downloaded, go to your smartphone's WiFi settings and select the connection; ZXM-AC5_XXXX. (XXXX will be your unique number to your ZXM-AC5). Please see section '**6.8 WiFi.**' For further information about connecting through WiFi.
2. Once you have connected the ZXM-AC5 to your smartphone a tick icon will appear next to the name. You can open the **ZX-ACTION APP** on your smartphone.

NOTE: Ensure that WiFi on the ZXM-AC5 and your smartphone are both turned on. If the WiFi on your smartphone is off, turn it on and refresh the search. To see how to turn on the WiFi for the ZXM-AC5, '**6.8 WiFi.**' Do not connect to any other WiFi when you are connecting the ZXM-AC5 to its App.

3. The App will prompt you to connect to a network. Make sure the ZXM-AC5_XXXX WiFi name is the one that comes up. If it doesn't connect to this prior to opening the app.

11.2 SAVING PHOTOS AND VIDEOS VIA THE APP

All files that are taken on the ZXM-AC5 will be automatically saved to the Micro SD card that is currently inserted into it. However, you can also save these files wirelessly onto your smartphone through the **ZX-ACTION APP**. To save photos wirelessly, follow the steps next page:

1. Launch the **ZX-ACTION APP** on your smartphone.
2. On the home screen, **PRESS** the circle with the image in it, this is on the left of the mode icon within the App.
3. Once you are in the gallery, you will see on the top bar of the App. One will be highlighted. If ZXM-AC5 is not highlighted, **PRESS** this tab.
4. **PRESS** the  **ICON** in the top right corner of the gallery page in the App to open the download screen. You will be prompted to select either **DOWNLOAD** or **DELETE**. **PRESS DOWNLOAD**.
5. You can now select all the files you wish to download by pressing on each photo you want, or if **PRESS ALL** on the bottom left corner of the screen to download all.
6. **PRESS CONFIRM** on the bottom right of the screen to begin the download.

11.3 REMOTE PHOTO/RECORD VIA THE APP

If you wish to use the App to remotely take a photo or record a video follow the below steps:

1. Launch the **ZX-ACTION APP** on your Smartphone.
2. The App will open with the **REMOTE SHOOTING** screen.
3. You can choose between video, camera and slow motion by clicking on the matching icons. (The large video or photo icon on the screen). Each icon will have the different shooting options appear above it. Select your preferred option.
4. **PRESS** the same icon for the mode you have chosen again to either take the photo or begin recording.

11.4 ADJUSTING SETTINGS VIA THE APP

If you prefer to change the settings of the ZXM-AC5 via the App you can do this through the settings tab. You can adjust the settings for the mode you are shooting in, as well as the software settings for the ZXM-AC5. Follow the below steps:

1. Press the  **ICON** on the top right of the App screen to edit the **PHOTO MODE** settings.

OR

2. Press the  **ICON** on the top right of the App screen to edit the software settings on the ZXM-AC5.

All the settings are listed on this screen under each category. To either change them or turn them on, press on the required tab and select the option you prefer.

12.0 WARRANTY TERMS & CONDITIONS

Our goods come with guarantees that cannot be excluded under the Australian Consumer Law. You are entitled to a replacement or refund for a major failure and for compensation for any other reasonably foreseeable loss or damage. You are also entitled to have the goods repaired or replaced if the goods fail to be of acceptable quality and the failure does not amount to a major failure.

This warranty is provided in addition to your rights under the Australian Consumer Law. Directed Electronics Australia Pty Ltd (Directed Electronics) warrants that this product is free from defects in material and workmanship for a period of 12 months from the date of purchase or for the period stated on the packaging. This warranty is only valid where you have used the product in accordance with any recommendations or instructions provided by Directed Electronics.

This warranty excludes defects resulting from alterations of the product, accident, misuse, abuse or neglect. In order to claim the warranty, you must return the product to the retailer from which it was purchased or if that retailer is part of a National network, a store within that chain, along with satisfactory proof of purchase. The retailer will then return the goods to Directed Electronics.

Directed Electronics will repair, replace or refurbish the product at its discretion. The retailer will contact you when the product is ready for collection. All costs involved in claiming this warranty, including the cost of the retailer sending the product to Directed Electronics, will be borne by you.

EMAIL: admin@zero-x.com.au

INDEMNITY

You agree to defend, indemnify and hold harmless Zero-X and its subsidiaries and affiliates from and against any and all claims, proceedings, injuries, liabilities, losses, costs and expenses (including reasonable legal fees), including but not limited to, claims alleging negligence, invasion of privacy, copyright infringement and/or trademark infringement against Zero-X and its subsidiaries and affiliates, relating to or arising out of your breach of any provision of these terms, your misuse of Zero-X products or its services, or your unauthorized modification or alteration of products or software.

WARRANTY AND WARRANTY DISCLAIMER

Zero-X has a limited warranty, whereby Zero-X warrants to you and only to you that this Zero-X Action Camera will be free from defects in materials and workmanship for one (1) year from the date of your purchase (unless a longer warranty period is required by law). The specifics of this Zero-X limited warranty are covered in this manual.

To the extent possible under governing law, other than the above product warranty for the Zero-X Action Camera you understand and agree that the Zero-X services are provided on an “as is” and “as available” basis.

Zero-X makes no warranty that the Zero-X product and services will meet your requirements or that use of the Zero-X services will be uninterrupted, timely, secure or error-free. Nor does Zero-X make any warranty as to the accuracy or reliability of any information obtained through Zero-X (including third party content), that any defects in the Zero-X products or services be corrected or

that the Zero-X products or Zero-X services will be compatible with any other specific hardware or service.

Further, Zero-X does not warrant that Zero-X products or services or Zero-X servers that provide you with data and content are free of viruses or other harmful components.

Zero-X also assumes no responsibility for and shall not be liable, for any damages caused by viruses that may infect your Zero-X. In the event of any loss, damage or injury, you will not look to Zero-X to compensate you or anyone else. You release and waive for yourself and your insurer all subrogation and other rights to recover against Zero-X arising as a result of the payment of any claim for loss, damage or injury.

Zero-X equipment and services do not cause and cannot eliminate occurrences of certain events, including, and Zero-X makes no guarantee or warranty, including any implied warranty of merchantability or fitness for a particular purpose, that the Zero-X equipment and services provided will detect or avert such incidents or their consequences.

Zero-X does not undertake any risk that you or property, or the person or property of others, may be subject to injury or loss if such an event occurs. The allocation of such risk remains with you, not Zero-X.

Other than the above product warranty for the Zero-X products, its suppliers disclaim all warranties of any kind, whether express, implied, or statutory, regarding the Zero-X services, including any implied warranty of title, merchantability, fitness for a particular purpose, or non-infringement of third party rights.

Because some jurisdictions do not permit the exclusion of implied warranties, the last sentence of this section may not apply to you.

Zero-X hereby further expressly disclaims all liability for any claims for service failures that are due to normal product wear, product misuse, abuse, product modification, improper product selection or your non-compliance with all applicable federal, state or local laws.

This warranty and warranty disclaimer give you specific legal rights, and you may have other rights that vary by state, province, or country. Other than as permitted by law, Zero-X does not exclude, limit or suspend other rights you have, including those that may arise from the nonconformity of a sales contract.

For a full understanding of your rights, you should consult the laws of your state, province, or country. For our Australian customers: Please note that this warranty is in addition to any statutory rights in Australia in relation to your goods which, pursuant to the Australian Consumer Law, cannot be excluded.

LIMITATIONS OF ZERO-X LIABILITY

Under no circumstances will Zero-X be liable in any way for any content, including, but not limited to, the loss of content, any errors or omissions in any content, or any loss or damage of any kind incurred in connection with use of or exposure to any content posted, emailed, accessed, transmitted, or otherwise made available via Zero-X.

Zero-X liability for damages, especially for breach of duty or obligation, delay in performance, non-performance, or malperformance shall be precluded, except when these are due to negligent breaches of any significant contractual duty or obligation on the part of Zero-X. Any liability for negligence is limited

to direct losses usually and typically foreseeable in such case. Should the claim for damages be based on wilful or grossly negligent breach of contractual duty or obligation on the part of Zero-X, the preclusion and limitation of liability mentioned in the preceding sentences will not apply. The preceding preclusion and limitation of liability will also not apply to claims for damages arising out of loss of life, bodily injury or health impacts for which Zero-X may be liable, or for non-contractual liability.

Some states and countries do not allow the exclusion or limitation of incidental or consequential damages, so the above limitation or exclusion may not apply to you. Additionally, this provision is not intended to limit Zero-X's liability in the event of Zero-X's wilful or intentional misconduct.

Capture the action.™

ZERO-X

ANOTHER
DIRECTED
BRAND



All Images, Information and Content are
Copyright © 2022 Directed Electronics
Australia Pty Ltd. All Rights Reserved.

www.zero-x.com.au | www.zero-x.co.nz